

Housed Bearing Units

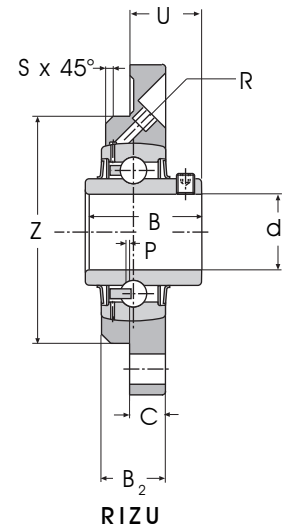

Series	RIZS	RIZH
	RIZU	RIZH-R3
	RIZ	RIZK

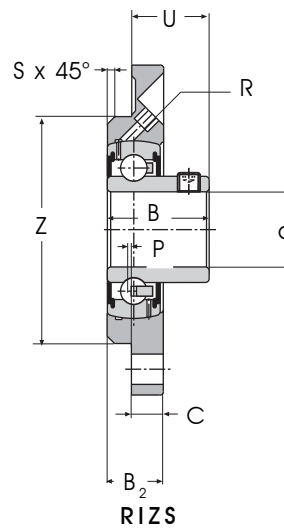
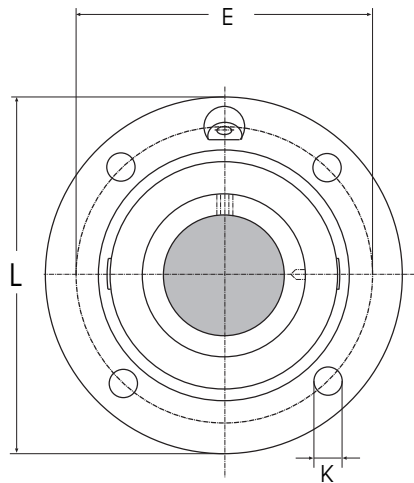

Unit Ref	Shaft Bearing		Weight kg	Dimensions mm							Load Rating					
	Diameter d	Ref		L	E	K	B ₂	C	U	B	Z _{h8}	P	R	s	Dynamic c kN	Static c ₀ kN
RIZ 20	20	SA 204	0,55	100	78	9	20	11,5	23	31,0	62	0,5	M6	2	12,8	6,6
RIZS 20		SB 204	0,50	100	78	9	20	11,5	17,5	25,0	62	0,5	M6	2	12,8	6,6
RIZU 20		UC 204	0,54	100	78	9	20	11,5	17,8	31,0	62	0,5	M6	2	12,8	6,6
RIZH 20		HC 204	0,57	100	78	9	20	11,5	25,9	43,5	62	0,5	M6	2	12,8	6,6
RIZH 20 R3		HC 204 R3	0,57	100	78	9	20	11,5	25,9	43,5	62	0,5	M6	2	12,8	6,6
RIZ 25	25	SA 205	0,75	115	90	9,5	21	11	22	31,0	70	1,5	M6	2	14,0	7,8
RIZS 25		SB 205	0,70	115	90	9,5	21	11	18	27,0	70	1,5	M6	2	14,0	7,8
RIZU 25		UC 205	0,75	115	90	9,5	21	11	18,3	34,1	70	1,5	M6	2	14,0	7,8
RIZH 25		HC 205	0,80	115	90	9,5	21	11	25,4	44,3	70	1,5	M6	2	14,0	7,8
RIZH 25 R3		HC 205 R3	0,80	115	90	9,5	21	11	25,4	44,3	70	1,5	M6	2	14,0	7,8
RIZK 25	20	UK 205	0,70	115	90	9,5	21	11	-	35,0	70	1,5	M6	2	14,0	7,8
RIZ 30	30	SA 206	0,98	124	100	11,5	20,5	10	25,2	35,7	80	1,5	M6	2	19,5	11,3
RIZS 30		SB 206	0,90	124	100	11,5	20,5	10	20,5	30,0	80	1,5	M6	2	19,5	11,3
RIZU 30		UC 206	1,00	124	100	11,5	20,5	10	20,7	38,1	80	1,5	M6	2	19,5	11,3
RIZH 30		HC 206	1,05	124	100	11,5	20,5	10	28,6	48,3	80	1,5	M6	2	19,5	11,3
RIZH 30 R3		HC 206 R3	1,05	124	100	11,5	20,5	10	28,6	48,3	80	1,5	M6	2	19,5	11,3
RIZK 30	25	UK 206	0,90	124	100	11,5	20,5	10	-	38,0	80	1,5	M6	2	19,5	11,3
RIZ 35	35	SA 207	1,30	134	110	11,5	23	10	28,4	38,9	90	1	M6	2	25,5	15,3
RIZS 35		SB 207	1,20	134	110	11,5	23	10	22,5	32,0	90	1	M6	2	25,5	15,3
RIZU 35		UC 207	1,30	134	110	11,5	23	10	24,4	42,9	90	1	M6	2	25,5	15,3
RIZH 35		HC 207	1,35	134	110	11,5	23	10	31,3	51,1	90	1	M6	2	25,5	15,3
RIZH 35 R3		HC 207 R3	1,35	134	110	11,5	23	10	31,1	51,1	90	1	M6	2	25,5	15,3
RIZK 35	30	UK 207	1,20	134	110	11,5	23	10	-	43,0	90	1	M6	2	25,5	15,3
RIZ 40	40	SA 208	1,60	145	120	11,5	23	11,5	31,7	43,7	100	1	M6	2	32,5	19,8
RIZS 40		SB 208	1,50	145	120	11,5	23	11,5	24	34,0	100	1	M6	2	32,5	19,8
RIZU 40		UC 208	1,65	145	120	11,5	23	11,5	29,2	49,2	100	1	M6	2	32,5	19,8
RIZH 40		HC 208	1,75	145	120	11,5	23	11,5	33,9	56,3	100	1	M6	2	32,5	19,8
RIZH 40 R3		HC 208 R3	1,75	145	120	11,5	23	11,5	33,9	56,3	100	1	M6	2	32,5	19,8
RIZK 40	35	UK 208	1,50	145	120	11,5	23	11,5	-	46,0	100	1	M6	2	32,5	19,8

Sleeves are not included in delivery

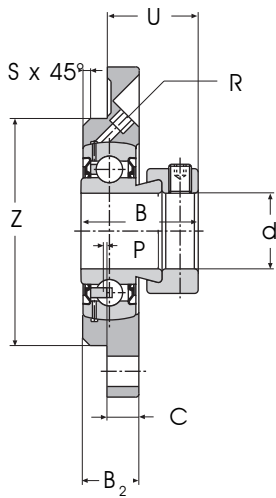

RIZ

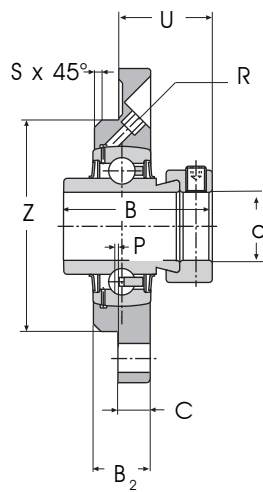

RIZH

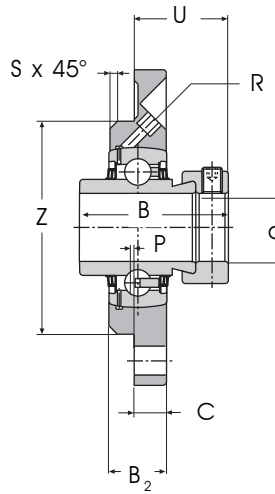

RIZH-R3

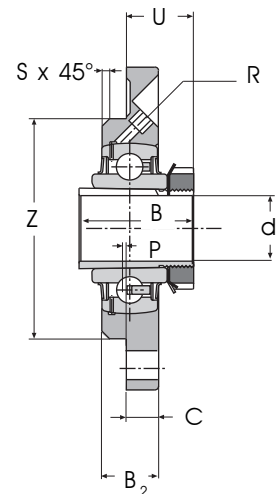

RIZK

Unit Ref	Shaft Diameter d	Bearing Ref	Weight kg	Dimensions mm										Load Rating		
				L	E	K	B ₂	C	U	B	Z _{h8}	P	R	s	Dynamic c kN	Static c ₀ kN
RIZ 45	45	SA 209	1,90	155	130	14	25	12	30,7	43,7	105	2	M6	2	32,5	20,4
RIZS 45		SB 209	1,80	155	130	14	25	12	29,0	41,2	105	2	M6	2	32,5	20,4
RIZU 45		UC 209	1,95	155	130	14	25	12	28,2	49,2	105	2	M6	2	32,5	20,4
RIZH 45		HC 209	2,10	155	130	14	25	12	32,9	56,3	105	2	M6	2	32,5	20,4
RIZH 45 R3		HC 209 R3	2,10	155	130	14	25	12	32,9	56,3	105	2	M6	2	32,5	20,4
RIZK 45	40	UK 209	1,80	155	130	14	25	12	-	50,0	105	2	M6	2	32,5	20,4
RIZ 50	50	SA 210	2,30	165	135	14	27,5	15,5	32,7	43,7	110	0	M6	3	35,0	23,2
RIZS 50		SB 210	2,15	165	135	14	27,5	15,5	32,7	43,5	110	0	M6	3	35,0	23,2
RIZU 50		UC 210	2,35	165	135	15	27,5	15,5	32,6	51,6	110	0	M6	3	35,0	23,2
RIZH 50		HC 210	2,55	165	135	14	27,5	15,5	38,1	62,7	110	0	M6	3	35,0	23,2
RIZH 50 R3		HC 210 R3	2,55	165	135	14	27,5	15,5	38,1	62,7	110	0	M6	3	35,0	23,2
RIZK 50	45	UK 210	2,15	165	135	14	27,5	15,5	-	55,0	110	0	M6	3	35,0	23,2
RIZ 60	60	SA 212	3,60	195	160	18	33	16	39,1	53,1	135	0,5	M6	3	52,0	36,0
RIZU 60		UC 212	3,50	195	160	18	33	16	39,2	65,1	135	0,5	M6	3	52,0	36,0
RIZH 60		HC 212	4,00	195	160	18	33	16	46,3	77,7	135	0,5	M6	3	52,0	36,0
RIZH 60 R3		HC 212 R3	4,00	195	160	18	33	16	46,3	77,7	135	0,5	M6	3	52,0	36,0
RIZK 60	55	UK 212	3,50	195	160	18	33	16	-	62,0	135	0,5	M6	3	52,0	36,0
RIZU 70	70	UC 214	5,10	215	177	18	32	18	44,4	74,6	150	0	R ¹ / ₈	3	62,0	44,0
RIZH 70		HC 214	5,70	215	177	18	32	18	44,6	66,1	150	0	R ¹ / ₈	3	62,0	44,0
RIZH 70 R3		HC 214 R3	5,70	215	177	18	32	18	44,6	66,1	150	0	R ¹ / ₈	3	62,0	44,0
RIZU 80	80	UC 216	5,75	220	184	18	32	18	51,3	82,6	160	-2	R ¹ / ₈	3	72,0	54,0
RIZH 80		HC 216	5,75	220	184	18	32	18	49,6	71,0	160	-2	R ¹ / ₈	3	72,0	54,0
RIZH 80 R3		HC 216 R3	5,75	220	184	18	32	18	49,6	71,0	160	-2	R ¹ / ₈	3	72,0	54,0
RIZU 90	90	UC 218	9,30	265	220	23	32	20	60,3	96	190	-4	R ¹ / ₈	3	102,0	79,0
RIZH 90		HC 218	8,80	265	220	23	32	20	50,5	69,5	190	-4	R ¹ / ₈	3	102,0	79,0
RIZH 100	100	HC 220	11,50	295	245	23	36	22	53,5	75	210	-4	R ¹ / ₈	3	122,0	80,0
RIZH 120	120	HC 224	17,50	350	295	27	40	24	56,5	81	250	-4	R ¹ / ₈	3	155,0	113,0